

F85 GEARBOXES

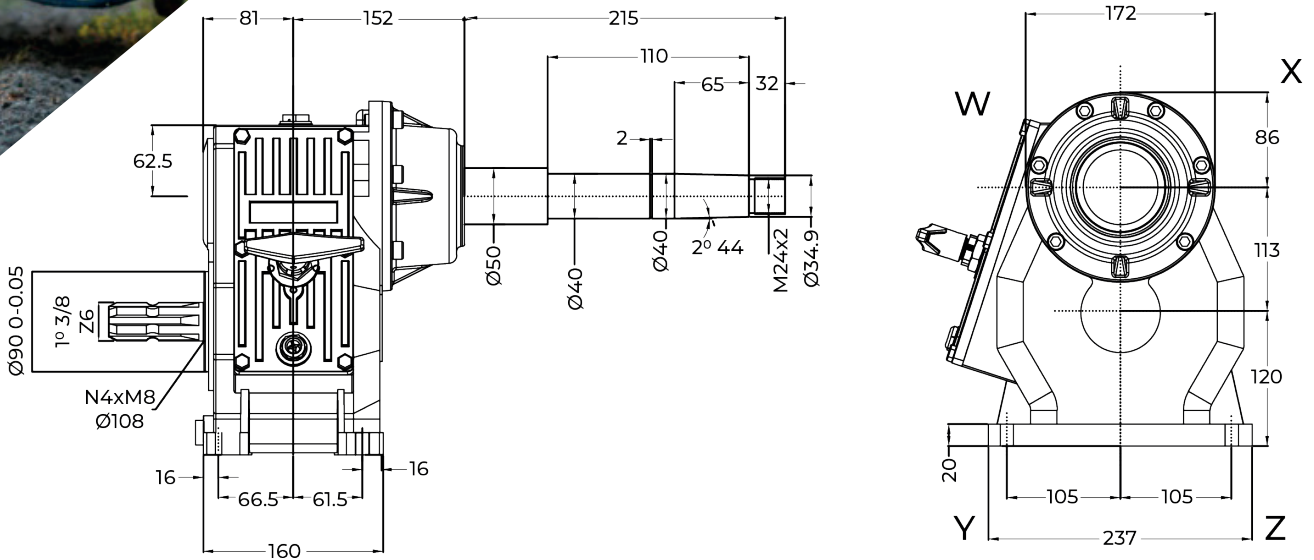

OVERDRAW GEARS	GEAR RATIO	INPUT REV gri/min-rpm	INPUT POWER		OUTPUT REV gri/min-rpm	CODE	WEIGHT
			CV	kW			
	1:3.61	540	30	40.5	1949.4	F85	31 Kg
	1:4.53	540	30	40.5	2446.2	BEARINGS	W 6303 Y 6307 X 6310 Z 6207

MATERIALS	SHAFTS	GEARS	BOX	TOOTHING	
	20MnCr5	16CrNi4	Cs400	C.T.R HELICOIDAL AND SHAVED TOOTH	

Gear ratio and output shaft length can be modified to fit customers' needs.